



swiss bed concept



*Schlafwohl*

Markenmatratzen & Bettsysteme



**OAKLINE/BIANCO**

EICHE MASSIV | CHÊNE MASSIF | SOLID OAK

Achten Sie auf FSC®-zertifizierte Produkte | Soyez attentifs aux produits certifiés FSC® | Look for FSC®-certified products



# Hasena – mein Bett

Hasena – mon lit | Hasena – my bed

## Beständige Passion

Une passion constante  
Enduring Passion



### Mehr als ein Lebenswerk

Als Familienunternehmen gegründet, überzeugen wir seit über 70 Jahren mit hoher Qualität und Vielseitigkeit im Bereich Schlafzimmermöbel.

### Plus que l'œuvre d'une vie

Fondée en tant qu'entreprise familiale, nous convainquons depuis plus de 70 ans par notre qualité élevée et notre polyvalence dans le domaine des meubles de chambre à coucher.

### More than a life's work

Founded as a family business, we have been impressing with high quality and versatility in the field of bedroom furniture for over 70 years.

## swiss bed concept



swiss bed concept

### Ein cleveres Baukastensystem

Sie wählen Ihren favorisierten Bettrahmen aus und kombinieren dazu Füße und Kopfteil Ihrer Wahl. Dabei können Sie quer durch die Kollektionen auf unterschiedliche Materialien und Farben zugreifen.

### Un système modulaire astucieux

Vous choisissez votre cadre de lit préféré et le combinez avec les pieds et les têtes de lit de votre choix. Vous pouvez choisir parmi une variété de matériaux et de couleurs dans toutes les collections.

### A clever modular system

You choose your favourite bed frame and combine it with the feet and headboards of your choice. You can choose from a variety of materials and colours throughout the collections.

## 5 Jahre Garantie

Service de livraison rapide  
5 years warranty



### Unser Versprechen

Vom Baum zum Bett – mittels handwerklicher Perfektion und hochwertigen Materialien. Sie erhalten 5 Jahre Garantie auf die Material- und Oberflächenbeschaffenheit, sowie die fachgerechte Verarbeitung aller Modelle ab Kaufdatum. Weitere Informationen finden Sie auf unserer Website.

### Notre promesse

De l'arbre au lit – grâce à un artisanat parfait et des matériaux de haute qualité. Vous bénéficiez d'une garantie de 5 ans sur la qualité des matériaux et des surfaces, ainsi que sur la fabrication professionnelle de tous les modèles à compter de la date d'achat. Vous trouverez plus d'informations sur notre site Internet.

### Our promise

From tree to bed – by means of perfect craftsmanship and high-quality materials. You receive a 5-year guarantee on the material and surface quality, as well as the professional workmanship of all models from the date of purchase. Further information can be found on our website.

## Schnellieferservice

Service de livraison rapide  
Quick delivery service



### Komfort ohne Wartezeit

Mit unserem Schnellieferservice «PRONTO» können wir eine grosse Auswahl an Betten mit Beimöbeln und alle Modelle aus Edition pronto, Dream pronto und Boxspring pronto ab Lager liefern.

### Le confort sans attente

Notre service de livraison rapide « PRONTO » permet de livrer un large choix de lits, de meubles d'appoint et tous les modèles de l'Édition Pronto, Dream pronto et Boxspring Pronto à partir du stock.

### Comfort without waiting

With our quick delivery service «PRONTO» we can offer a large selection of beds with ancillary furniture and all models from models from Edition pronto, Dream pronto and Boxspring pronto from stock.







## Vielseitig kombinierbar

Unser ausgeklügeltes Baukastensystem «swiss bed concept» bietet eine riesige Auswahl an Füßen, Kopfteilen und Beimöbeln. Darüber hinaus umfasst es verschiedene Stoff-, Kunstleder- und Lederbezüge sowie diverse Holz- und Metallausführungen. Abgestimmte Lattenroste und Matratzen komplettieren unsere Betten zur Wohlfühloase.

## Combinable à versatile

Notre système modulaire sophistiqué «swiss bed concept» propose un choix énorme de pieds, têtes de lits et accessoires. Par ailleurs le comporte différents tissus, cuirs synthétiques et véritables, ainsi que diverses variantes de bois et métal. Des sommiers à lattes et des matelas adaptés complètent nos lits pour un espace bien-être.

## Versatile combinable

Our ingenious modular system «swiss bed concept» offers a huge selection of feet, headboards and accessories. In addition, it includes different fabrics, synthetic leather and real leather covers and different wood and metal versions. Matching slatted frames and mattresses complete our beds to an oasis of well-being.

## Nachhaltigkeit bei Hasena

Unser wichtigster Lieferant, die Natur, ist sensibel und benötigt lange Regenerationszeiten bei Überbeanspruchung. Wir respektieren die von uns genutzten Ökosysteme und stellen unsere Produkte nachhaltig und mit hohem sozialen Engagement her.



## Soziale Verantwortung

Responsabilité sociale  
Social responsibility



## Holzoberflächen

Surfaces en bois  
Wood surfaces



## Stabil im Aufbau

Unsere Betten überzeugen durch eine hohe Stabilität. Mittels Einsatz verschiedener Traversen ist eine gesamthafte Belastung von 300 bis 450 kg, inklusive Lattenroste und Matratzen, möglich.

## Construction robuste

Nos lits sont convainçants par leur grande stabilité. En utilisant différentes fermes, une charge totale de 300 à 450 kg, y compris les sommiers à lattes et les matelas, est possible.

## Solid in construction

Our beds convince with their high stability. By using different trusses, a total load of 300 to 450 kg, including slatted frames and mattresses, is possible.

## Durabilité chez Hasena

Notre fournisseur le plus important, la nature, est sensible et nécessite un long temps de régénération en cas de surutilisation. Nous respectons les écosystèmes que nous utilisons et fabriquons nos produits de manière durable et avec un haut niveau d'engagement social.



## Holzbeschaffung

Approvisionnement en bois  
Wood procurement



## Recycelte Stoffe

Tissus recyclés  
Recycled fabrics



## Einfach in der Montage

Unser Betten-System begeistert durch einen einfachen Aufbau mit leicht verständlicher Montageanleitung sowie hochwertigen Verbindungselementen, welche einen vielfachen Ab- und Wiederaufbau ermöglichen.

## Montage facile

Notre système de lits séduit par une installation facile grâce aux instructions de montage bien compréhensibles ainsi que par les éléments de fixation haut de gamme permettant de monter et démonter les lits à de nombreuses reprises.

## Solid in construction

Our beds convince with their high stability. By using different trusses, a total load of 300 to 450 kg, including slatted frames and mattresses, is possible.

## Sustainability at Hasena

Our most important supplier, nature, is sensitive and needs long regeneration times in case of overuse. We respect the ecosystems we use and manufacture our products sustainably and with a high level of social commitment.



## Produktion Massivholz

Production bois massif  
Manufacturing solid wood



## Energiegewinnung

Production énergétique  
Production of energy







# OAK LINE

EICHE MASSIV | CHÊNE MASSIF | SOLID OAK



# Bettrahmen | Cadre de lit | Bedframe

## Modul 18

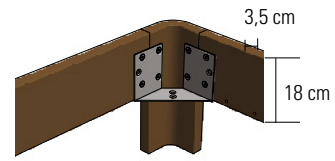

**Breiten** | Largeurs | Widths:  
90, 100, 120, 140, 160, 180, 200 cm

**Längen** | Longueurs | Lengths:  
190, 200, 210, 220 cm

**Einlegetiefe** | Hauteur encastrable | Insertion depth:  
18 cm

## Traversen | Traverses | Bars

**Wir empfehlen grundsätzlich den Einsatz von Crosstraver (Quertraverse) oder Midtraver (Längstraverse).**

Nous recommandons en général l'utilisation de Crosstraver (traverse transversale) ou Midtraver (traverse centrale).

We recommend basically the insertion of Crosstraver (central cross bar) or Midtraver (central bar).

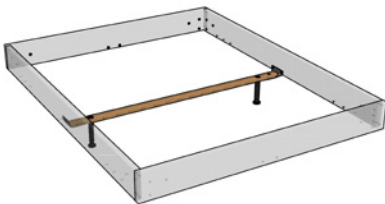

### Crosstraver

Quertraverse | Traverse transversale | Central cross bar

**Für alle Bettbreiten** | Pour toutes les largeurs de lit | For all bed widths

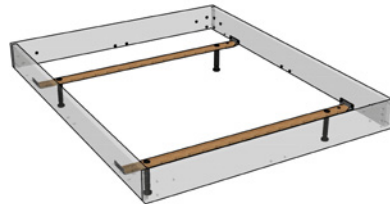

### Crosstraver-Twin

Quertraversen | Traverses transversales | Cross bars

**Für alle Bettbreiten** | Pour toutes les largeurs de lit | For all bed widths

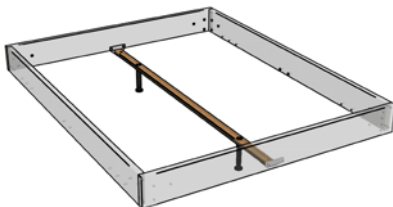

### Midtraver

Längstraverse | Traverse centrale | Central bar

**Für Betten ab Breite 140 cm mit 2 Lattenrosten oder Motorrahmen-einbau** | Pour les lits à partir de 140 cm de largeur avec 2 sommiers ou l'installation d'un cadre motorisé | For beds from 140 cm width with 2 slats or motor frame installation

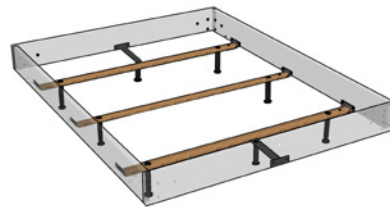

### Crosstraver-XXL

Quertraversen | Traverses transversales | Cross bars

**Für alle Bettbreiten** | Pour toutes les largeurs de lit | For all bed widths

**Übersicht Kompatibilität Traversen siehe Gesamtkatalog Seite 2.12** | Aperçu compatibilité traverses voir catalogue général page 2.12 | Overview compatibility bars see general catalogue page 2.12

## Ausführungen | Exécutions | Executions

### Holz | Bois | Wood



86

**Eiche natur, gebürstet, geölt**

Chêne naturel, brossé, huilé  
Oak natural, brushed, oiled



89

**Eiche graphit, gebürstet, geölt**

Chêne graphit, brossé, huilé  
Oak graphit, brushed, oiled

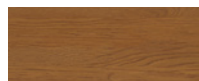

91

**Eiche cognac, gebürstet, geölt**

Chêne cognac, brossé, huilé  
Oak cognac, brushed, oiled



# Füsse | Pieds | Feet

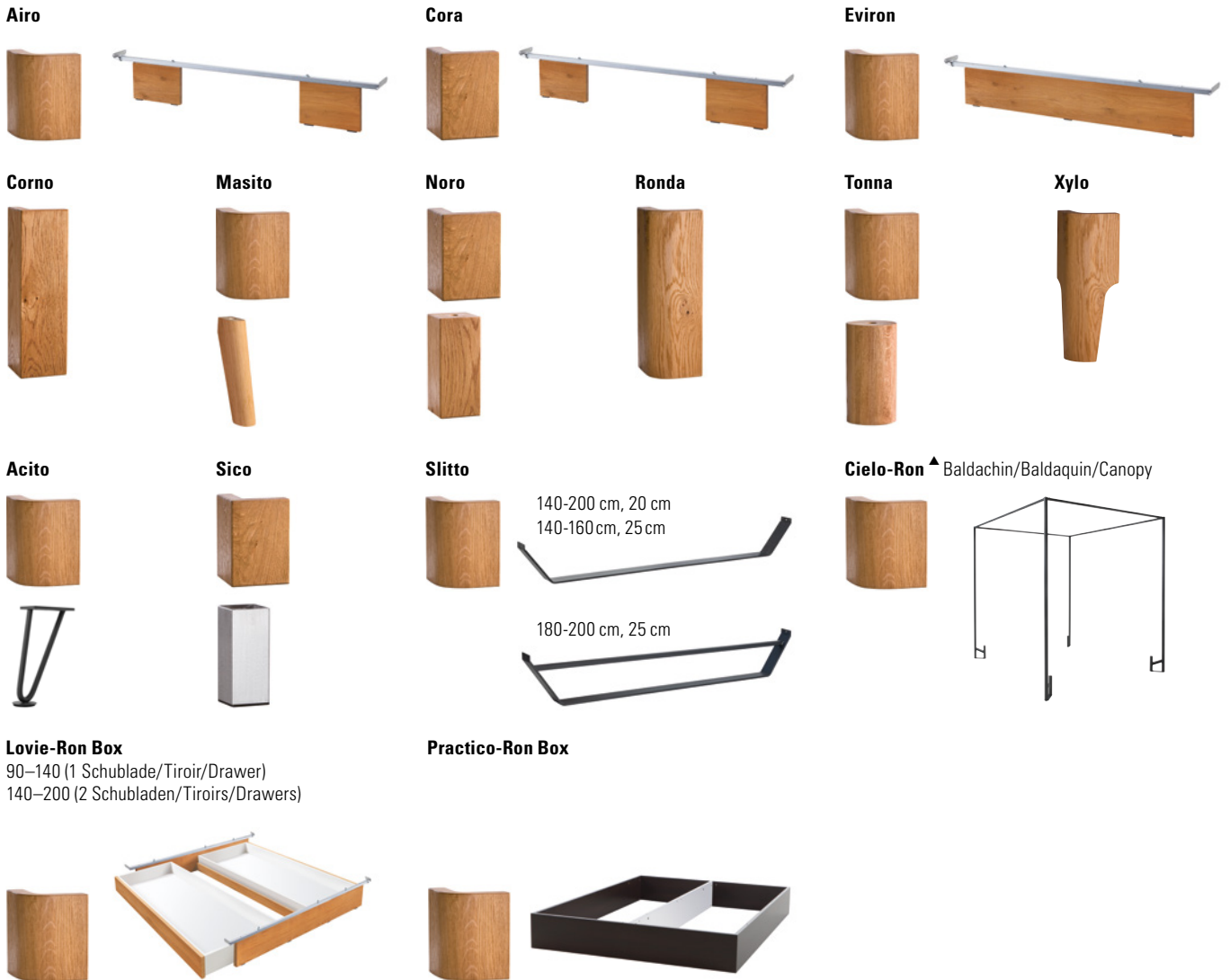

**Lovie-Ron Box**  
90–140 (1 Schublade/Tiroir/Drawer)  
140–200 (2 Schubladen/Tiroirs/Drawers)

**Practico-Ron Box**

## Holz | Bois | Wood

	Breiten cm Largeurs cm Widths cm	Höhen cm Hauteurs cm Heights cm			Holzfarben Couleurs bois Colours wood				
		20	25	30	10	16	86	89	91
Airo	90–200	●					●	●	●
Cora	90–200	●					●	●	●
Corno		●	●	●			●	●	●
Eviron	90–200		●		●	●	●	●	●
Lovie-Ron Box (1 Schublade/Tiroir/Drawer)	90–140		●		●	●	●	●	●
Lovie-Ron Box (2 Schubladen/Tiroirs/Drawers)	140–200		●		●	●	●	●	●
Masito		●	●				●	●	●
Noro		●	●	●			●	●	●
Practico-Ron Box*	90–200		●		●	●	●	●	●
Ronda		●	●	●			●	●	●
Tonna		●	●	●			●	●	●
Xylo		●	●	●			●	●	●

## Metall | Métal | Metal

	Breiten cm Largeurs cm Widths cm	Höhen cm Hauteurs cm Heights cm			Metallfarben Couleurs métal Colours metal			
		20	25	30	10	16	42	43
Acito		●				●		
Cielo-Ron <sup>▲</sup>	120–200	●			●	●		
Sico		●	●	●				●
Slitto	140–200	●	●		●	●	●	

<sup>▲</sup> **Curty Vorhang und Vela Baldachin-Tuch siehe Gesamtkatalog Register 2, Seite 2.7** | Curty rideau et Vela tissu de baldaquin voir catalogue général registre 2, page 2.7 | Curty curtain and Vela canopy cloth see general catalogue index 2, page 2.7

**Eckfüsse/Eckteile + Füße (inkl. Beschläge)** | Pieds d'angles/Pièces d'angles + Pieds (Visserie incl.) | Corner feet, Corner pieces + Feet (Fittings included)

\*weiss/anthrazit = MDF  
\*blanc/anthracite = MDF  
\*white/anthracite = MDF

## Metall | Métal | Metal



10 Weiss | Blanc | White

16 Anthracit

42 Alu

43 Inox

# Kopfteile | Têtes de lit | Headboards

## Alpa



Dimension: 140, 160, 180, 200

## Soleo



Dimension: 140, 160, 180, 200

## Lisio



Dimension: 90/100, 120, 140, 160, 180, 200

## Varus



Dimension: 90/100, 120, 140, 160, 180, 200

## gepolstert | rembourrées | upholstered

### Cemoa



Dimension: 90, 100, 120, 140, 160, 180, 200 (90-120 = 1 Kissen | Coussin | Cushion)

<b>Gewünschte Liegefläche (Länge)</b>	<b>= zu bestellende Bettrahmenlänge</b>
Surface de couchage souhaitée (Longueur)	= longueur de cadre de lit à commander
Desired mattress lying area (Length)	= length of bedframe to be ordered
<b>190</b>	<b>= 200</b>
<b>200</b>	<b>= 210</b>
<b>210</b>	<b>= 220</b>

**Nur montierbar mit runden Ecken.** | Montage uniquement possible avec des angles ronds. | Can only be assembled with round edges. (Füsse | Pieds | Feet: Airo, Eviron, Masito, Practico-Ron Box, Ronda, Slitto, Tonna, Xylo, Cielo-Ron, Lovie-Ron Box).

**Das Kopfteil Cemoa enthält in Echtleder keine Teilungsnähte.**

En cuir véritable, la tête de lit Cemoa ne comporte pas de coutures de séparation. The Cemoa headboard contains no dividing seams in genuine leather.

## Adapter | Adaptateur | Adapter

**Bei hohen Matratzen kann mit dem Verlängerungsadapter das Kopfteil um 9 oder 13 cm erhöht werden.**

La tête de lit peut être rehaussée de 9 ou 13 cm avec l'adaptateur lorsque le matelas est plus épais. With the extension adapter the headboard can be extended 9 or 13 cm if mattresses are high.

### Head-Plus Metall | Métal | Metal



black

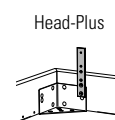
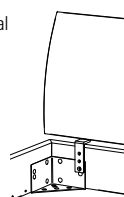

↑  
+9 / +13 cm

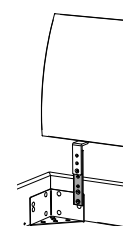



# Kissen zu Kopfteilen | Coussins pour têtes de lit | Cushions for headboards

**Arona + Alpa**



**Lumo + Alpa**



**Ravo + Varus**



**Sano + Alpa**



**Suny + Varus**



**Varo + Varus**



**Befestigung mit 2 Bändern (Klettverschluss)**

Fixation avec 2 bandes Velcro®  
Fixation with 2 ribbons (Velcro®fastener)

**Kissen | Coussins | Cushions**

**Effektive Masse cm**  
Dimensions effectives cm  
Effective dimensions cm

**zu Kopfteilen**  
pour têtes de lit  
for headboards

**Breitenmasse cm**  
Dimensions de largeur cm  
Widths dimensions cm

	Effektive Masse cm Dimensions effectives cm Effective dimensions cm	zu Kopfteilen pour têtes de lit for headboards		Breitenmasse cm Dimensions de largeur cm Widths dimensions cm
		Alpa	Varus	
Arona	86, 116, 136, 156, 176×3,5×25	●		140, 160, 180/200
Lumo	86, 116, 136, 156, 176×6×25	●		140, 160, 180/200
Ravo	80, 110, 130, 150, 170, 190×3,5×35	●	●	90/100, 120, 140, 160, 180, 200
Sano (2er Set   set de 2   set of 2)	55×4×35	●		
Suny (2er Set   set de 2   set of 2)	55×6×40	●	●	
Varo (2er Set   set de 2   set of 2)	55×10×35		●	

**Alle Kissen in Echtleder haben Zier- sowie Teilungsnähte. Ausnahmen: Ravo, Suny und Varo, diese Kissen haben lediglich Ziernähte.** | Tous les coussins en cuir véritable ont des coutures décoratives et des coutures de séparation. A l'exception des coussins : Ravo, Suny et Varo, ces coussins ont uniquement des coutures décoratives. | All cushions in genuine leather have decorative and dividing seams. Exceptions: Ravo, Suny and Varo, these cushions only have decorative seams.

## Ausführungen | Exécutions | Executions

### Holz | Bois | Wood

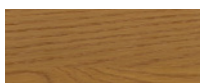

**86**  
**Eiche natur, gebürstet, geölt**  
Chêne naturel, brossé, huilé  
Oak natural, brushed, oiled



**89**  
**Eiche graphit, gebürstet, geölt**  
Chêne graphit, brossé, huilé  
Oak graphit, brushed, oiled

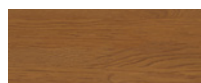

**91**  
**Eiche cognac, gebürstet, geölt**  
Chêne cognac, brossé, huilé  
Oak cognac, brushed, oiled

# selezione

## 01

### MODELLAUSWAHL

Sélection du modèle | Model selection

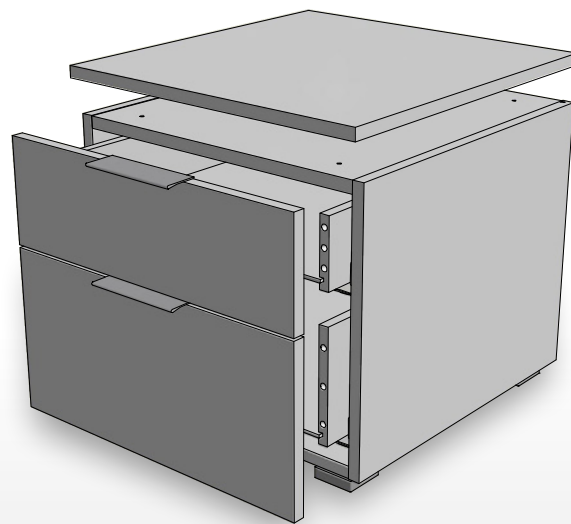

**Twia**



45/50/41 cm

**Onia**



45/50/41 cm

**Owita**



90/50/41 cm

**Trio**



45/50/55 cm

**Dowe**



45/50/55 cm

**Dowio**



90/50/55 cm

**Quatro**



45/50/86 cm

**Unito**



45/50/86 cm

**Qunito**



90/50/86 cm

**Quatrine**



90/50/86 cm

**Portina**



90/50/86 cm

**Atrine**



90/50/86 cm

**Totrino**



135/50/86 cm

**Cassino**



135/50/86 cm

**Incentro**



135/50/86 cm

**Trequatri**



135/50/86 cm

**Stellen Sie sich Ihr Wunsch-Beimöbel nach Ihrem Geschmack zusammen: Der Korpus (Abb. 02), in zwei verschiedenen Farbvarianten, lässt sich zu den Front- und Top-Covern (Abb. 03) in acht Holz- und Farbausführungen kombinieren. Die Beimöbel können zerlegt oder teilmontiert bestellt werden. Bei zusammengesetzten Möbeln (z. B. Qunito, Incentro, ...) muss der Deckel noch montiert werden. Bei Kommoden mit Türen ist jeweils ein Einlegeboden vorhanden, Türöffnung nach links oder rechts möglich. Zusätzliche Böden sind erhältlich.**

Composez le meuble d'appoint de vos rêves selon vos goûts : Le caisson (ill. 02), disponible en 2 variantes de couleurs, peut être combiné avec les façades et couvercles supérieurs (ill. 03) en 8 finitions de bois et de coloris. Les meubles d'appoint peuvent être commandés en kits ou assemblés. Pour les meubles assemblés (p. ex. Qunito, Incentro, ...) le couvercle doit encore être fixé. Les commodes avec portes sont équipées d'une étagère, ouverture de la porte possible à gauche ou à droite. Si besoin, des étagères supplémentaires sont disponibles.

Put together the side furniture you want according to your own taste: The body (fig. 02), in two different colour versions, can be combined with the front and top covers (fig. 03) in eight wood and colour versions. The furniture can be ordered disassembled or assembled. For assembled furniture (e.g. Qunito, Incentro, ...) the top cover must still be fitted. Chests of drawers with doors have one shelf, door opening possible to the left or right. Additional shelves are available.



**Kombinationsbeispiele und techn. Informationen**  
Exemples et informations  
Examples and informations



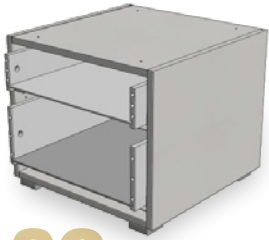

# 02

## KORPUS

Caisson | Body



# 03

## TOP/FRONT

Farben | Couleurs | Colours

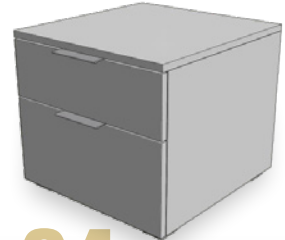

# 04

## GRIFFE

Poignées | Handles



10 Weiss | Blanc | White



16 Anthracit | Anthracite



## FÜSSE

Pieds | Feet

### STANDARD



### OPTION

Leg 8 cm

Jone 10 cm

Cila 10 cm



alu



anthracit  
used



anthracit



10 Weiss | Blanc | White



16 Anthracit | Anthracite

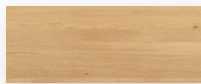

74 Eiche bright, geölt  
Chêne bright, huilé  
Oak bright, oiled

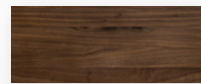

82 Nussbaum, geölt  
Noyer, huilé  
Walnut, oiled

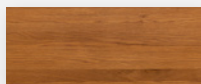

76 Eiche brandy, geölt  
Chêne brandy, huilé  
Oak brandy, oiled



87 Wildbuche natur, geölt  
Hêtre nouveau naturel, huilé  
Wildbeech natural, oiled



80 Kernbuche natur, geölt  
Hêtre coeur rouge  
naturel, huilé  
Heart beech natural, oiled

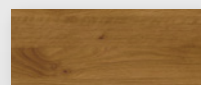

99 Wildeiche natur, geölt  
Chêne nouveau naturel, huilé  
Wildoak natural, oiled

### STANDARD



Alu

#### Griff zu Folienfronten

Poignée pour façades en mélaminé  
Handle for foil fronts

### STANDARD



#### Holzgriff zu Holzfronten

Poignée en bois pour façades en bois  
Wooden handle for wooden fronts

### OPTION

#### Rivo



Used



Anthracit

#### Metalgriff zu Holzfronten

Poignée en métal pour façades en bois  
Metal handle for wooden fronts



The mark of  
responsible forestry  
FSC® C123546

Look for FSC® certified products



				<b>Dimension cm</b>
<b>Totrino</b>	Kommode	Commode	Chest of drawers	135/50/86
<b>Twia</b>	Nachttisch	Table de nuit	Bedside table	45/50/41
<b>Sola</b>	Bank	Table de nuit	Bedside table	140/37/38
<b>Vano</b>	Kissen, Campos blanc 372	Coussin, Campos blanc 372	Cushion, Campos blanc 372	136/34/3

**Alle Holzteile in Eiche cognac, gebürstet, geölt und weiss** | Toutes les parties en bois en chêne cognac, brossé, huilé et blanc | All wooden parts in oak cognac, brushed, oiled and white

**Weitere Beimöbel siehe Gesamtkatalog Register 2** | Autres accessoires voir catalogue général registre 2 | Further accessories see general catalogue index 2





				<b>Dimension cm</b>
<b>Modul 18</b>	Rahmen Breiten Längen	Cadre Largeurs Longueurs	Frame Widths Lengths	140, 160, 180, 200 190, 200, 210, 220
<b>Masito</b>	Füße, Eckteile Höhen	Pieds, Pièces d'angles Hauteurs	Feet, Corner pieces Heights	20, 25
<b>Soleo</b>	Kopfteil	Tête de lit	Headboard	140, 160, 180, 200

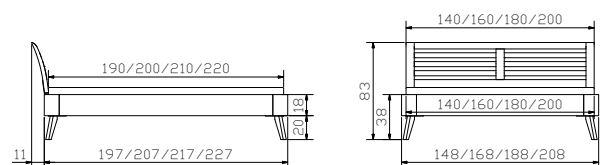





				Dimension cm
<b>Modul 18</b>	Rahmen Breiten Längen	Cadre Largeurs Longueurs	Frame Widths Lengths	90, 100, 120, 140, 160, 180, 200 190, 200, 210, 220
<b>Xylo</b>	Eckfüsse Höhen	Pieds d'angles Hauteurs	Corner feet Heights	20(38), 25(43), 30(48)
<b>Gabo</b>	Kopfteil, Campos blanc 372 siehe Gesamtkatalog Register 1	Tête de lit, Campos blanc 372 voir catalogue général registre 1	Headboard, Campos blanc 372 see general catalogue index 1	90, 100, 120, 140, 160, 180, 200

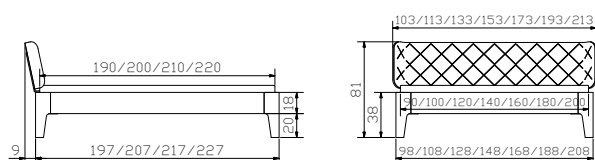

**Alle Holzteile in Eiche natur, gebürstet, geölt**

Toutes les parties en bois en chêne naturel, brossé, huilé  
All wooden parts in oak natural, brushed, oiled

**Weitere Beimöbel siehe Gesamtkatalog Register 2**

Autres accessoires voir catalogue général registre 2  
Further accessories see general catalogue index 2





				<b>Dimension cm</b>
<b>Modul 18</b>	Rahmen Breiten Längen	Cadre Largeurs Longueurs	Frame Widths Lengths	90, 100, 120, 140, 160, 180, 200 190, 200, 210, 220
<b>Xylo</b>	Eckfüsse Höhen	Pieds d'angles Hauteurs	Corner feet Heights	20(38), 25(43), 30(48)
<b>Lisio</b>	Kopfteil	Tête de lit	Headboard	90/100, 120, 140, 160, 180, 200
<b>Koro</b>	Nachttisch	Table de nuit	Bedside table	50/40/57

**Alle Holzteile in Eiche cognac, gebürstet, geölt**

Toutes les parties en bois en chêne cognac, brossé, huilé  
All wooden parts in oak cognac, brushed, oiled

**Weitere Beimöbel siehe Gesamtkatalog Register 2**

Autres accessoires voir catalogue général registre 2  
Further accessories see general catalogue index 2

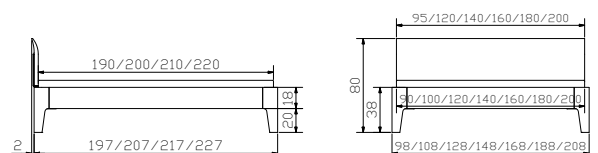





				<b>Dimension cm</b>
<b>Sola</b>	Bank	Banquette	Bench	140/37/38
<b>Topia</b>	Kissen, Campos blanc 372	Coussin, Campos blanc 372	Cushion, Campos blanc 372	140/37/10
<b>Cara</b>	Nachttisch	Table de nuit	Bedside table	50/40/40
<b>Vela</b>	Baldachin-Tuch, Baumwolle weiss	Tissu de baldaquin, Coton blanc	Canopy cloth, Cotton white	
	Breiten	Largeurs	Widths	120, 140, 160, 180, 200
	Länge	Longueur	Length	200
<b>Curty</b>	Baldachin-Vorhang (3er Set)	Rideau de baldaquin (set de 3)	Curtain of canopy (set of 3)	272/185 (3x)
	Baumwolle weiss	Coton blanc	Cotton white	







				Dimension cm
<b>Modul 18</b>	Rahmen Breiten Längen	Cadre Largeurs Longueurs	Frame Widths Lengths	120, 140, 160, 180, 200 190, 200, 210, 220
<b>Cielo-Ron white</b>	Baldachin Breiten Längen Höhe	Baldaqin Largeurs Longueurs Hauteur	Canopy Widths Lengths Height	120, 140, 160, 180, 200 200, 210, 220 20
<b>Ripo</b>	Kopfteil, Campos blanc 372	Tête de lit, Campos blanc 372	Headboard, Campos blanc 372	120, 140, 160, 180, 200

**Alle Holzteile in Eiche natur, gebürstet, geölt**

Toutes les parties en bois en chêne naturel, brossé, huilé  
All wooden parts in oak natural, brushed, oiled

**Weitere Beimöbel siehe Gesamtkatalog Register 2**

Autres accessoires voir catalogue général registre 2  
Further accessories see general catalogue index 2

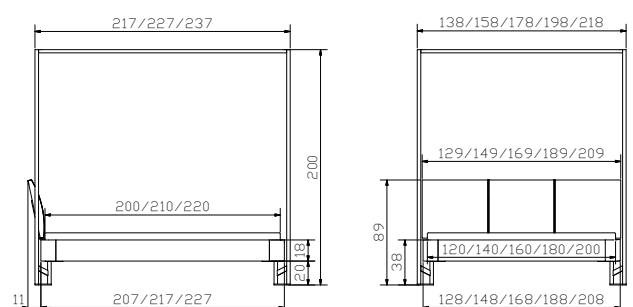





	<b>Dimension cm</b>			
<b>Cemoa</b>	Kopfteil, Fusio shell 750 hat Einfluss auf Bettlänge siehe Seite 10.6	Tête de lit, Fusio shell 750 a un impact sur la longueur du lit voir page 10.6	Headboard, Fusio shell 750 affects the length of bed see 10.6	90, 100, 120, 140, 160, 180, 200 90 – 120 = 1 Kissen/Coussin/ Cushion
<b>Boga</b>	Kopfteil, Fusio shell 750 siehe Gesamtkatalog Register 1	Tête de lit, Fusio shell 750 voir catalogue général registre 1	Headboard, Fusio shell 750 see general catalogue index 1	90, 100, 120, 140, 160, 180, 200

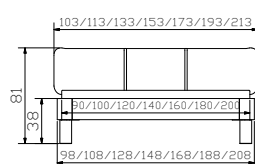
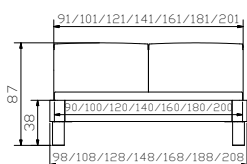





				<b>Dimension cm</b>
<b>Modul 18</b>	Rahmen Breiten Längen	Cadre Largeurs Longueurs	Frame Widths Lengths	90, 100, 120, 140, 160, 180, 200 190(200), 200(210), 210(220)
<b>Slitto white</b>	Kufen, Eckteile Breiten Höhen	Patins, Pièces d'angles Largeurs Hauteurs	Vats, Corner pieces Widths Heights	140, 160, 180, 200 20, 25
<b>Cemoa</b>	Kopfteil, Campos blanc 372  hat Einfluss auf Bettlänge siehe Seite 8	Tête de lit, Campos blanc 372  a un impact sur la longueur du lit voir page 8	Headboard, Campos blanc 372  affects the length of bed see page 8	90, 100, 120, 140, 160, 180, 200 90 – 120 = 1 Kissen/Coussin/ Cushion
<b>Aida</b>	Kommode	Commode	Chest of drawers	105/40/75
<b>Cara</b>	Nachttisch	Table de nuit	Bedside table	50/40/40

**Alle Holzteile in Eiche natur, gebürstet, geölt**

Toutes les parties en bois en chêne naturel, brossé, huilé  
All wooden parts in oak natural, brushed, oiled

**Weitere Beimöbel siehe Gesamtkatalog Register 2**

Autres accessoires voir catalogue général registre 2  
Further accessories see general catalogue index 2

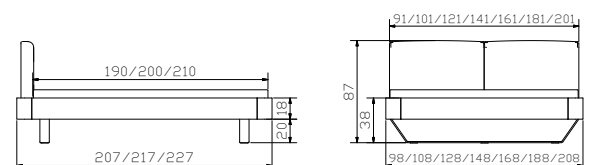





**Lovie-Ron Box**

1 Bettkasten  
Breiten  
2 Bettkästen  
Breiten  
Höhe

1 Tiroir de lit  
Largeurs  
2 Tiroirs de lit  
Largeurs  
Hauteur

1 Bed drawer  
Widths  
2 Bed drawers  
Widths  
Height

**Dimension cm**

90, 100, 120, 140  
140, 160, 180, 200  
25

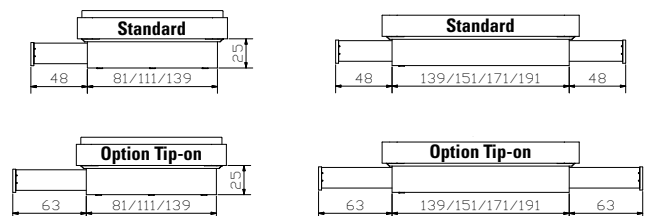





				<b>Dimension cm</b>
<b>Modul 18</b>	Rahmen Breiten Längen	Cadre Largeurs Longueurs	Frame Widths Lengths	140, 160, 180, 200 190, 200, 210, 220
<b>Slitto anthracit</b>	Kufen, Eckteile Breiten Höhen	Patins, Pièces d'angles Largeurs Hauteurs	Vats, corner pieces Widths Heights	140, 160, 180, 200 20, 25
<b>Cussina</b>	Kopfteil, Fusio musk 752 siehe Gesamtkatalog Register 1	Tête de lit, Fusio musk 752 voir catalogue général registre 1	Headboard, Fusio musk 752 see general catalogue index 1	140, 160, 180, 200
<b>Topa anthracit</b>	Bank inkl. Kissen Fusio musk 752	Banquette, Coussin incl. Fusio musk 752	Bench, cushion incl. Fusio musk 752	144/44/38
<b>Caja</b>	Nachttisch	Table de nuit	Bedside table	48/41/16

**Alle Holzteile in Eiche graphit, gebürstet, geölt**

Toutes les parties en bois en chêne graphit, brossé, huilé  
All wooden parts in oak graphit, brushed, oiled

**Weitere Beimöbel siehe Gesamtkatalog Register 2**

Autres accessoires voir catalogue général registre 2  
Further accessories see general catalogue index 2

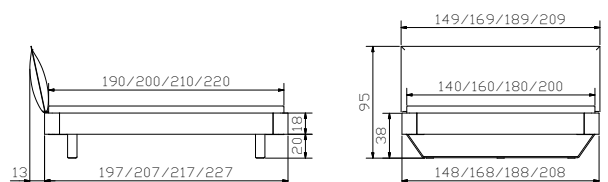







# OAK BIANCO

EICHE MASSIV | CHÊNE MASSIF | SOLID OAK



# Bettrahmen | Cadre de lit | Bedframe

## Modul 18

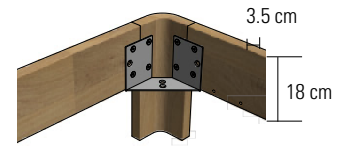

**Breiten** | Largeurs | Widths:  
90, 100, 120, 140, 160, 180, 200 cm

**Längen** | Longueurs | Lengths:  
190, 200, 210, 220 cm

**Einlegetiefe** | Hauteur encastrable | Insertion depth:  
18 cm

## Traversen | Traverses | Bars

**Wir empfehlen grundsätzlich den Einsatz von Crosstraver (Quertraverse) oder Midtraver (Längstraverse).**

Nous recommandons en général l'utilisation de Crosstraver (traverse transversale) ou Midtraver (traverse centrale).

We recommend basically the insertion of Crosstraver (central cross bar) or Midtraver (central bar).

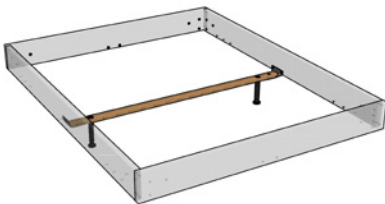

### Crosstraver

Quertraverse | Traverse transversale | Central cross bar

**Für alle Bettbreiten** | Pour toutes les largeurs de lit | For all bed widths

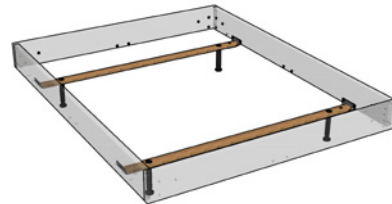

### Crosstraver-Twin

Quertraversen | Traverses transversales | Cross bars

**Für alle Bettbreiten** | Pour toutes les largeurs de lit | For all bed widths

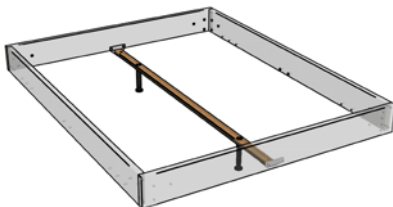

### Midtraver

Längstraverse | Traverse centrale | Central bar

**Für Betten ab Breite 140 cm mit 2 Lattenrosten oder Motorrahmen-einbau** | Pour les lits à partir de 140 cm de largeur avec 2 sommiers ou l'installation d'un cadre motorisé | For beds from 140 cm width with 2 slats or motor frame installation

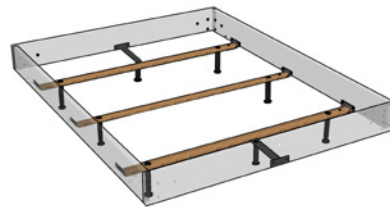

### Crosstraver-XXL

Quertraversen | Traverses transversales | Cross bars

**Für alle Bettbreiten** | Pour toutes les largeurs de lit | For all bed widths

**Übersicht Kompatibilität Traversen siehe Gesamtkatalog Seite 2.12** | Aperçu compatibilité traverses voir catalogue général page 2.12 | Overview compatibility bars see general catalogue page 2.12

## Ausführungen | Exécutions | Executions

### Holz | Bois | Wood



73

**Eiche bianco, gebürstet, geölt**

Chêne bianco, brossé, huilé

Oak bianco, brushed, oiled



# Füsse | Pieds | Feet

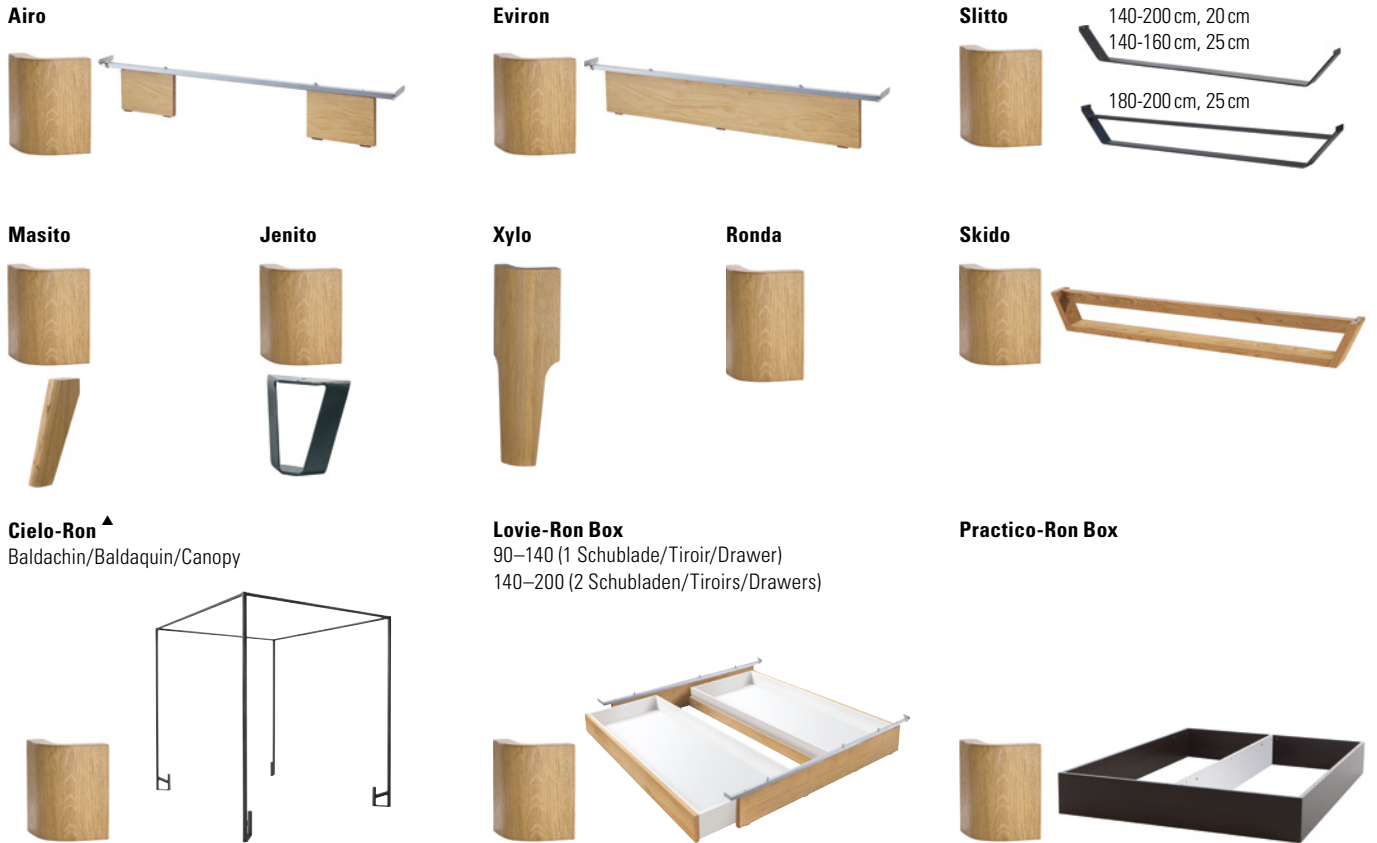

**Eckfüsse/Eckteile + Füsse (inkl. Beschläge)**  
Pieds d'angles/Pièces d'angles + Pieds (Visserie incl.)  
Corner feet/Corner pieces + Feet (Fittings included)

	Breiten cm Largeurs cm Widths cm		Höhen cm Hauteurs cm Heights cm			Holzfarben Couleurs bois Colours wood			Metallfarben Couleurs métal Colours metal			
			20	25	30	10	16	73	04	10	16	42
Airo	90–200		●					●				
Cielo-Ron <sup>▲</sup>	120–200		●					●		●		
Eviron	90–200			●				●				
Lovie-Ron Box (1 Schublade/tiroir/drawer)	90–140			●				●				
Lovie-Ron Box (2 Schubladen/tiroirs/drawers)	140–200			●				●				
Practico-Ron Box* (inkl. Boden fond inclus   bottom included)	90–200			●		●	●	●				
Ronda			●	●	●			●				
Jenito			●	●				●	●			
Masito			●	●				●				
Slitto	140–200		●	●				●		●	●	●
Skido				●				●				
Xylo			●	●	●			●				

\*weiss/anthrazit = MDF | \*blanc/anthracite = MDF | \*white/anthracite = MDF

<sup>▲</sup> Curty Vorhang und Vela Baldachin-Tuch siehe Gesamtkatalog Register 2, Seite 2.7 | Curty rideau et Vela tissu de baldachin voir catalogue général registre 2, page 2.7 | Curty curtain and Vela canopy cloth see general catalogue index 2, page 2.7

## Ausführungen | Exécutions | Executions

### Metall | Métal | Metal

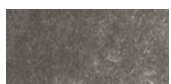

**04**  
used

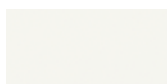

**10**  
white



**16**  
Anthracit



**42**  
Alu

**04 Used = Stahl galvanisiert** | Acier galvanisé | Steel galvanised

**10 White = Stahl pulverbeschichtet** | Acier thermolaqué | Steel powder-coated

**16 Anthracit = Stahl pulverbeschichtet** | Acier thermolaqué | Steel powder-coated

**42 Alu = Stahl pulverbeschichtet** | Acier thermolaqué | Steel powder-coated

# Kopfteile | Têtes de lit | Headboards

## Alpa

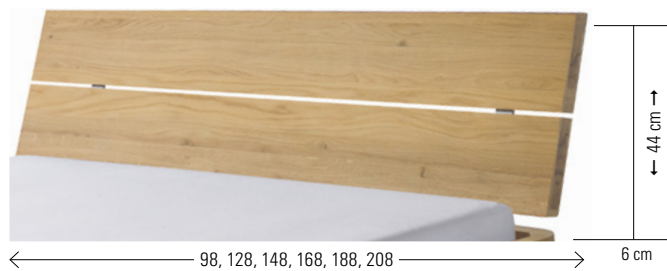

**Dimension:** 90/100, 120, 140, 160, 180, 200

## Varus



**Dimension:** 140, 160, 180, 200

## Edda



**Dimension:** 90/100, 120, 140, 160, 180, 200

## gepolstert | rembourrées | upholstered

### \*Cemoa



**Dimension:** 90, 100, 120, 140, 160, 180, 200 (90–120 = 1 Kissen | Coussin | Cushion)

**Gewünschte Liegefläche (Länge) = zu bestellende Bettrahmenlänge**

Surface de couchage souhaitée (Longueur) = longueur de cadre de lit à commander

Desired mattress lying area (Length) = length of bedframe to be ordered

**190 = 200**

**200 = 210**

**210 = 220**

**\*Nur montierbar mit runden Ecken.** | Montage uniquement possible avec des angles ronds. | Can only be assembled with round edges.  
(Füße | Pieds | Feet: Airo, Eviron, Masito, Jenito, Practico-Ron Box, Ronda, Slitto, Tonna, Xylo, Cielo-Ron, Lovie-Ron Box).

**Das Kopfteil Cemoa enthält in Echtleder keine Teilungsnähte.**

En cuir véritable, la tête de lit Cemoa ne comporte pas de coutures de séparation.  
The Cemoa headboard contains no dividing seams in genuine leather.

## Adapter | Adaptateur | Adapter

**Bei hohen Matratzen kann mit dem Verlängerungsadapter das Kopfteil um 9 oder 13 cm erhöht werden.**

La tête de lit peut être rehaussée de 9 ou 13 cm avec l'adaptateur lorsque le matelas est plus épais.

With the extension adapter the headboard can be extended 9 or 13 cm if mattresses are high.

**Head-Plus  
Metall | Métal | Metal**



black

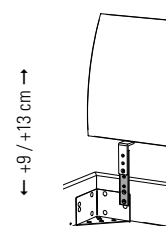
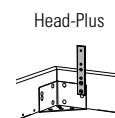
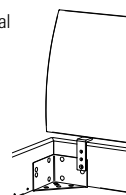



# Kissen zu Kopfteilen | Coussins pour têtes de lit | Cushions for headboards

**Arona + Alpa**



**Lumo + Alpa**



**Ravo + Varus**



**Sano + Alpa**



**Suny + Varus**



**Varo + Varus**



**Befestigung mit 2 Bändern (Klettverschluss)**

Fixation avec 2 bandes (velcro®)

Fixation with 2 ribbons (Velcro® fastener)

**Kissen | Coussins | Cushions**

**Effektive Masse cm**

Dimensions effectives cm  
Effective dimensions cm

**zu Kopfteilen**

pour têtes de lit  
for headboards

**Breitenmasse cm**

Dimensions de largeur cm  
Widths dimensions cm

	Effektive Masse cm Dimensions effectives cm Effective dimensions cm	zu Kopfteilen pour têtes de lit for headboards		Breitenmasse cm Dimensions de largeur cm Widths dimensions cm
		Alpa	Varus	
Arona	86, 116, 136, 156, 176×3,5×25	●		90/100, 120, 140, 160, 180/200
Lumo	86, 116, 136, 156, 176×6×25	●		90/100, 120, 140, 160, 180/200
Ravo	80, 110, 130, 150, 170, 190×3,5×35	●	●	90/100, 120, 140, 160, 180, 200
Sano (2er Set   set de 2   set of 2)	55×4×35	●		
Suny (2er Set   set de 2   set of 2)	55×6×40	●	●	
Varo (2er Set   set de 2   set of 2)	55×10×35		●	

**Alle Kissen in Echtleder haben Zier- sowie Teilungsnähte. Ausnahmen: Ravo, Suny und Varo, diese Kissen haben lediglich Ziernähte.** | Tous les coussins en cuir véritable ont des coutures décoratives et des coutures de séparation. A l'exception des coussins : Ravo, Suny et Varo, ces coussins ont uniquement des coutures décoratives. | All cushions in genuine leather have decorative and dividing seams. Exceptions: Ravo, Suny and Varo, these cushions only have decorative seams.



**Gepolsterte Kopfteile, Wandpaneele, Stoffauswahl/Farben siehe Gesamtkatalog Register 1, Leselampen siehe Gesamtkatalog Register 2.**

Têtes de lits rembourrées, panneaux muraux, choix de tissus/couleurs voir catalogue général registre 1, lampes de lecture voir registre 2.

Upholstered headboards, wallpanels, choice of tissues/colours see general catalogue index 1, reading lamps see general index 2.



				<b>Dimension cm</b>
<b>Portina</b>	Kommode	Commode	Chest of drawers	90/50/96
<b>Dowe</b>	Nachttisch	Table de nuit	Bedside table	45/50/55
<b>Sola</b>	Bank	Banquette	Bench	140/37/38
<b>Claudio</b> alu	Herrendiener	Valet	Dressboy	45/28/107

**Alle Holzteile in Eiche bianco, gebürstet, geölt** | Toutes les parties en bois en chêne bianco, brossé, huilé | All wooden parts in oak bianco, brushed, oiled

**Portina, Dowe: Eiche bright, geölt und anthracit** | Chêne bright, huilé et anthracite | Oak bright, oiled and anthracite

**Weitere Beimöbel siehe Gesamtkatalog Register 2** | Autres accessoires voir catalogue général registre 2 | Further accessories see general catalogue index 2





				<b>Dimension cm</b>
<b>Modul 18</b>	Rahmen Breiten Längen	Cadre Largeurs Longueurs	Frame Widths Lengths	140, 160, 180, 200 190, 200, 210, 220
<b>Skido</b>	Kufen, Eckteile Breiten Höhe	Patins, Pièces d'angles Largeurs Hauteur	Vats, Corner pieces Widths Height	140, 160, 180, 200 25
<b>Varus</b>	Kopfteil	Tête de lit	Headboard	140, 160, 180, 200
<b>Ravo</b>	Kissen, Boucle mouse 773	Coussin, Boucle mouse 773	Cushion, Boucle mouse 773	140, 160, 180, 200

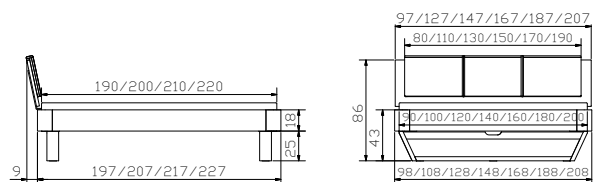





				<b>Dimension cm</b>
<b>Atrine</b>	Kommode siehe Gesamtkatalog Register 2	Commode voir catalogue général registre 2	Chest of drawers see general catalogue index 2	90/50/86
<b>Onia</b>	Nachttisch siehe Gesamtkatalog Register 2	Table de nuit voir catalogue général registre 2	Bedside table see general catalogue index 2	45/50/41
<b>Sola Topia</b>	Bank Kissen, Fusio shell 750	Banquette Coussin, Fusio shell 750	Bench Cushion, Fusio shell 750	140/37/38

**Alle Holzteile in Eiche bianco, gebürstet, geölt oder Eiche bright, geölt** | Toutes les parties en bois en chêne bianco, brossé, huilé ou chêne bright, huilé | All wooden parts in oak bianco, brushed, oiled or oak bright, oiled

**Atrine, Onia: Eiche bright, geölt und weiss** | Chêne bright, huilé et blanc | Oak bright, oiled and white

**Weitere Beimöbel siehe Gesamtkatalog Register 2** | Autres accessoires voir catalogue général registre 2 | Further accessories see general catalogue index 2





				<b>Dimension cm</b>
<b>Modul 18</b>	Rahmen Breiten Längen	Cadre Largeurs Longueurs	Frame Widths Lengths	90, 100, 120, 140, 160, 180, 200 190, 200, 210, 220
<b>Xylo</b>	Eckfüsse Höhen	Pieds d'angles Hauteurs	Corner feet Heights	20(38), 25(43), 30(48)
<b>Elipsa</b>	Kopfteil, Fusio shell 750 siehe Gesamtkatalog Register 1	Tête de lit, Fusio shell 750 voir catalogue général registre 1	Headboard, Fusio shell 750 see general catalogue index 1	90, 100, 120, 140, 160, 180, 200

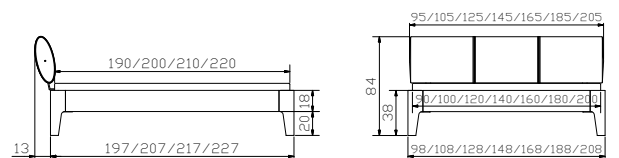





**MOVIE-/TOP LINE**



**FACTORY LINE**



**WOOD LINE**



**LOUNGE**



**FINE LINE**



**NATURO LINE**



**OAK LINE**



**OAK WILD**



**DREAM LINE**



**EDITION  
BOXSPRING**



**FUNCTION/COMFORT  
KIDS & GUESTS**



**LATTENROSTE &  
MATRATZEN**



**Gesamtkatalog**  
Catalogue général  
General catalogue

  
**Schlafwohl**  
Markenmatratzen & Bettsysteme