



swiss bed concept



Schlafwohl

Markenmatratzen & Bettsysteme



FINE LINE

MASSIVHOLZ | BOIS MASSIF | SOLID WOOD

Achten Sie auf FSC®-zertifizierte Produkte | Soyez attentifs aux produits certifiés FSC® | Look for FSC®-certified products



Hasena – mein Bett

Hasena – mon lit | Hasena – my bed

Beständige Passion

Une passion constante
Enduring Passion



Mehr als ein Lebenswerk

Als Familienunternehmen gegründet, überzeugen wir seit über 70 Jahren mit hoher Qualität und Vielseitigkeit im Bereich Schlafzimmermöbel.

Plus que l'œuvre d'une vie

Fondée en tant qu'entreprise familiale, nous convainquons depuis plus de 70 ans par notre qualité élevée et notre polyvalence dans le domaine des meubles de chambre à coucher.

More than a life's work

Founded as a family business, we have been impressing with high quality and versatility in the field of bedroom furniture for over 70 years.

swiss bed concept



swiss bed concept

Ein cleveres Baukastensystem

Sie wählen Ihren favorisierten Bettrahmen aus und kombinieren dazu Füße und Kopfteil Ihrer Wahl. Dabei können Sie quer durch die Kollektionen auf unterschiedliche Materialien und Farben zugreifen.

Un système modulaire astucieux

Vous choisissez votre cadre de lit préféré et le combinez avec les pieds et les têtes de lit de votre choix. Vous pouvez choisir parmi une variété de matériaux et de couleurs dans toutes les collections.

A clever modular system

You choose your favourite bed frame and combine it with the feet and headboards of your choice. You can choose from a variety of materials and colours throughout the collections.

5 Jahre Garantie

Service de livraison rapide
5 years warranty



Unser Versprechen

Vom Baum zum Bett – mittels handwerklicher Perfektion und hochwertigen Materialien. Sie erhalten 5 Jahre Garantie auf die Material- und Oberflächenbeschaffenheit, sowie die fachgerechte Verarbeitung aller Modelle ab Kaufdatum. Weitere Informationen finden Sie auf unserer Website.

Notre promesse

De l'arbre au lit – grâce à un artisanat parfait et des matériaux de haute qualité. Vous bénéficiez d'une garantie de 5 ans sur la qualité des matériaux et des surfaces, ainsi que sur la fabrication professionnelle de tous les modèles à compter de la date d'achat. Vous trouverez plus d'informations sur notre site Internet.

Our promise

From tree to bed – by means of perfect craftsmanship and high-quality materials. You receive a 5-year guarantee on the material and surface quality, as well as the professional workmanship of all models from the date of purchase. Further information can be found on our website.

Schnellieferservice

Service de livraison rapide
Quick delivery service



Komfort ohne Wartezeit

Mit unserem Schnellieferservice «PRONTO» können wir eine grosse Auswahl an Betten mit Beimöbeln und alle Modelle aus Edition pronto, Dream pronto und Boxspring pronto ab Lager liefern.

Le confort sans attente

Notre service de livraison rapide « PRONTO » permet de livrer un large choix de lits, de meubles d'appoint et tous les modèles de l'Édition Pronto, Dream pronto et Boxspring Pronto à partir du stock.

Comfort without waiting

With our quick delivery service «PRONTO» we can offer a large selection of beds with ancillary furniture and all models from models from Edition pronto, Dream pronto and Boxspring pronto from stock.





Vielseitig kombinierbar

Unser ausgeklügeltes Baukastensystem «swiss bed concept» bietet eine riesige Auswahl an Füßen, Kopfteilen und Beimöbeln. Darüber hinaus umfasst es verschiedene Stoff-, Kunstleder- und Lederbezüge sowie diverse Holz- und Metallausführungen. Abgestimmte Lattenroste und Matratzen komplettieren unsere Betten zur Wohlfühloase.

Combinable à versatile

Notre système modulaire sophistiqué «swiss bed concept» propose un choix énorme de pieds, têtes de lits et accessoires. Par ailleurs le comporte différents tissus, cuirs synthétiques et véritables, ainsi que diverses variantes de bois et métal. Des sommiers à lattes et des matelas adaptés complètent nos lits pour un espace bien-être.

Versatile combinable

Our ingenious modular system «swiss bed concept» offers a huge selection of feet, headboards and accessories. In addition, it includes different fabrics, synthetic leather and real leather covers and different wood and metal versions. Matching slatted frames and mattresses complete our beds to an oasis of well-being.

Nachhaltigkeit bei Hasena

Unser wichtigster Lieferant, die Natur, ist sensibel und benötigt lange Regenerationszeiten bei Überbeanspruchung. Wir respektieren die von uns genutzten Ökosysteme und stellen unsere Produkte nachhaltig und mit hohem sozialen Engagement her.



Soziale Verantwortung

Responsabilité sociale
Social responsibility



Holzoberflächen

Surfaces en bois
Wood surfaces



Stabil im Aufbau

Unsere Betten überzeugen durch eine hohe Stabilität. Mittels Einsatz verschiedener Traversen ist eine gesamthafte Belastung von 300 bis 450 kg, inklusive Lattenroste und Matratzen, möglich.

Construction robuste

Nos lits sont convainçants par leur grande stabilité. En utilisant différentes fermes, une charge totale de 300 à 450 kg, y compris les sommiers à lattes et les matelas, est possible.

Solid in construction

Our beds convince with their high stability. By using different trusses, a total load of 300 to 450 kg, including slatted frames and mattresses, is possible.

Durabilité chez Hasena

Notre fournisseur le plus important, la nature, est sensible et nécessite un long temps de régénération en cas de surutilisation. Nous respectons les écosystèmes que nous utilisons et fabriquons nos produits de manière durable et avec un haut niveau d'engagement social.



Holzbeschaffung

Approvisionnement en bois
Wood procurement



Recycelte Stoffe

Tissus recyclés
Recycled fabrics



Einfach in der Montage

Unser Betten-System begeistert durch einen einfachen Aufbau mit leicht verständlicher Montageanleitung sowie hochwertigen Verbindungselementen, welche einen vielfachen Ab- und Wiederaufbau ermöglichen.

Montage facile

Notre système de lits séduit par une installation facile grâce aux instructions de montage bien compréhensibles ainsi que par les éléments de fixation haut de gamme permettant de monter et démonter les lits à de nombreuses reprises.

Solid in construction

Our beds convince with their high stability. By using different trusses, a total load of 300 to 450 kg, including slatted frames and mattresses, is possible.

Sustainability at Hasena

Our most important supplier, nature, is sensitive and needs long regeneration times in case of overuse. We respect the ecosystems we use and manufacture our products sustainably and with a high level of social commitment.



Produktion Massivholz

Production bois massif
Manufacturing solid wood



Energiegewinnung

Production énergétique
Production of energy



Bettrahmen | Cadre de lit | Bedframe



Syma 18

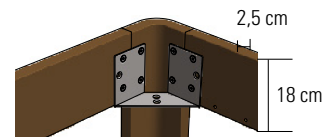

Breiten | Largeurs | Widths:
90, 100, 120, 140, 160, 180, 200 cm

Längen | Longueurs | Lengths:
190, 200, 210, 220 cm

Einlegetiefe | Hauteur encastrable | Insertion depth:
18 cm

Traversen | Traverses | Bars

Wir empfehlen grundsätzlich den Einsatz von Crosstraver (Quertraverse) oder Midtraver (Längstraverse).

Nous recommandons en général l'utilisation de Crosstraver (traverse transversale) ou Midtraver (traverse centrale).

We recommend basically the insertion of Crosstraver (central cross bar) or Midtraver (central bar).

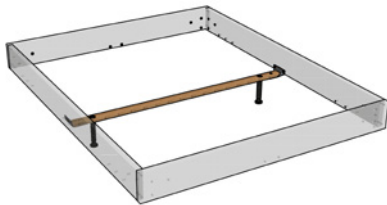

Crosstraver

Quertraverse | Traverse transversale | Central cross bar

Für alle Bettbreiten | Pour toutes les largeurs de lit | For all bed widths

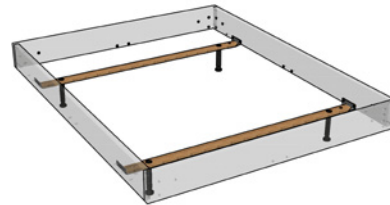

Crosstraver-Twin

Quertraversen | Traverses transversales | Cross bars

Für alle Bettbreiten | Pour toutes les largeurs de lit | For all bed widths

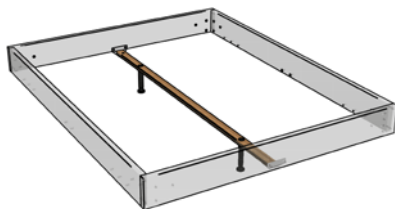

Midtraver

Längstraverse | Traverse centrale | Central bar

Für Betten ab Breite 140 cm mit 2 Lattenrosten oder Motorrahmen-einbau | Pour les lits à partir de 140 cm de largeur avec 2 sommiers ou l'installation d'un cadre motorisé | For beds from 140 cm width with 2 slats or motor frame installation

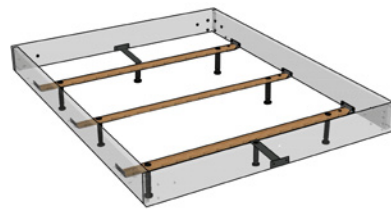

Crosstraver-XXL

Quertraversen | Traverses transversales | Cross bars

Für alle Bettbreiten | Pour toutes les largeurs de lit | For all bed widths

Übersicht Kompatibilität Traversen siehe Gesamtkatalog Seite 2.12 | Aperçu compatibilité traverses voir catalogue général page 2.12 | Overview compatibility bars see general catalogue page 2.12

Ausführungen | Exécutions | Executions

Holz | Bois | Wood

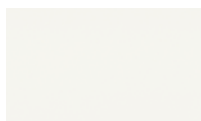

10
Buche weiss
deckend, lackiert
Hêtre blanc couvrant, laqué
Beech white covered,
lacquered

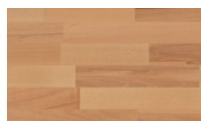

80
Kernbuche natur, geölt
Hêtre cœur rouge
naturel, huilé
Heart beech natural, oiled

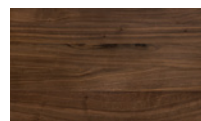

82
Nussbaum, geölt
Noyer, huilé
Walnut, oiled

Füsse | Pieds | Feet



Facito



Masito



Syko



Tondito



Ronda



Xylo



Lovie-Ron Box



90–140 (1 Schublade/Tiroir/Drawer)
140–200 (2 Schubladen/Tiroirs/Drawers)

Practico-Ron Box



Airo



Eviron



***Cielo-Ron**

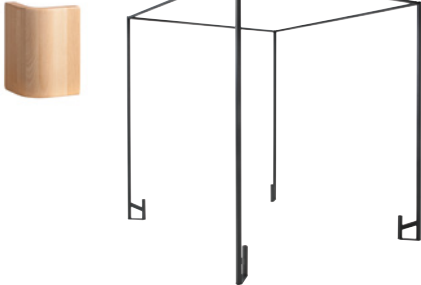

***Curty Vorhang und Vela Baldachin-Tuch siehe Gesamtkatalog Seite 2.7**

Curty rideau et Vela tissu de baldachin voir catalogue général page 2.7
Curty curtain and Vela canopy cloth see general catalogue page 2.7

Slitto

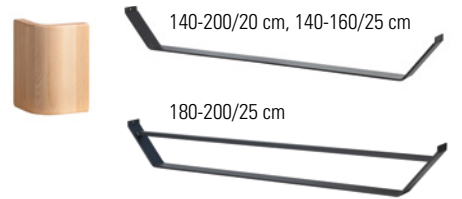

Holz | Bois | Wood

	Breiten cm Largeurs cm Widths cm	Höhen cm Hauteurs cm Heights cm			Holzfarben Couleurs bois Colours wood			
		20	25	30	10	16	80	82
Airo	90–200	●	■		●	■	●	■
Eviron	90–200		●		●	●	●	■
Lovie-Ron Box (1 Schublade/Tiroir/Drawer)	90–140		●		●	●	●	■
Lovie-Ron Box (2 Schubladen/Tiroirs/Drawers)	140–200		●		●	●	●	■
Practico-Ron Box*	90–200		●		●	●	●	
Masito		●	●		●	■	●	●
Ronda		●	●	●	●	●	●	●
Xylo		●	●	●	●	■	●	●

Kufen und Boxfronten ausschliesslich in weiss oder anthrazit | Patins et façades box exclusivement en blanc ou en anthracite | Vats and box fronts in white or anthracite only

Holz | Bois | Wood



10
Buche weiss deckend, lackiert
Hêtre blanc couvrant, laqué
Beech white covered, lacquered



80
Kernbuche natur, geölt
Hêtre cœur rouge naturel, huilé
Heart beech natural, oiled



82
Nussbaum, geölt
Noyer, huilé
Walnut, oiled



16
Buche anthracit deckend, lackiert
Hêtre blanc couvrant, laqué
Beech white covered, lacquered

***weiss/anthracit = MDF**
blanc/anthracite = MDF
white/anthracite = MDF

Metall | Métal | Metal

	Breiten cm Largeurs cm Widths cm	Höhen cm Hauteurs cm Heights cm			Metallfarben Couleurs métal Colours metal			
		20	25	30	00	10	16	42
Cielo-Ron [▲]	120–200	●	■			●	●	
Facito		●					●	
Syko		●	●	●	●			●
Slitto	140–200	●	●			●	●	●
Tondito		●					●	●

Metall | Métal | Metal



00
Chrom



10
White



16
Anthracit



42
Alu

00 Chrom = Metall verchromt | Métal chromé | Metal chrome
10 White = Metall pulverbeschichtet | Métal thermolaqué | Metal powder-coated
16 Anthracit = Metall pulverbeschichtet | Métal thermolaqué | Metal powder-coated
42 Alu = Stahl pulverbeschichtet | Métal thermolaqué | Metal powder-coated

Kopfteile | Têtes de lit | Headboards



Duetto

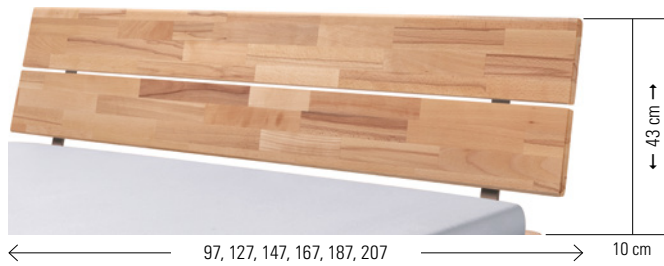

Dimension: 90/100, 120, 140, 160, 180, 200

Varus



Dimension: 140, 160, 180, 200

Vola

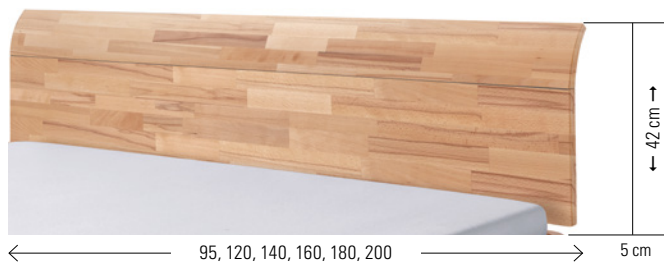

Dimension: 90/100, 120, 140, 160, 180, 200

Adapter | Adaptateur | Adapter

Bei hohen Matratzen kann mit dem Verlängerungsadapter das Kopfteil erhöht werden. | La tête de lit peut être rehaussée avec l'adaptateur lorsque le matelas est plus épais. | With the extension adapter the headboard can be extended if mattresses are high.

Head-Plus (2er Set | set of 2 | set of 2)

Metall | Métal | Metal

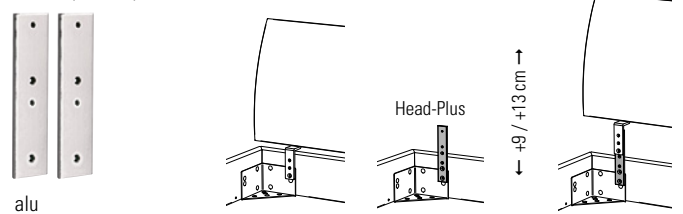

gepolstert | rembourrées | upholstered

Cemoa*



Dimension: 90, 100, 120, 140, 160, 180, 200 (90–120 = 1 Kissen | Coussin | Cushion)

Gewünschte Liegefläche (Länge) = zu bestellende Bettrahmenlänge

Surface de couchage souhaitée (longueur) = longueur de cadre de lit à commander

Desired mattress lying area (length) = length of bedframe to be ordered

190 = 200

200 = 210

210 = 220

Leselampe | Lampe de lecture | Reading lamp

Leselampe bei Holz- und gepolsterten Kopfteilen montierbar

La lampe de lecture peut être montée sur des têtes de lit en bois et rembourrées. Reading lamp can be assembled on wooden and upholstered headboards

Smart black (2er Set | set of 2 | set of 2)



Weitere Leselampen und technische Details siehe Gesamtkatalog Register 2, Seite 2.11

Autres lampes de lecture et détails techniques voir catalogue général registre 2, page 2.11

Further reading lamps and technical details see general catalogue index 2, page 2.11

***Das Kopfteil Cemoa enthält in Echtleder keine Teilungsnähte.**

En cuir véritable, la tête de lit Cemoa ne comporte pas de coutures de séparation.

The Cemoa headboard contains no dividing seams in genuine leather.

Ausführungen | Exécutions | Executions

Holz | Bois | Wood

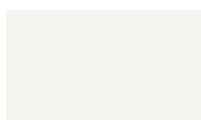

10
Buche weiss deckend, lackiert
Hêtre blanc couvrant, laqué
Beech white covered, lacquered

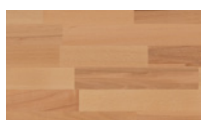

80
Kernbuche natur, geölt
Hêtre cœur rouge naturel, huilé
Heart beech natural, oiled

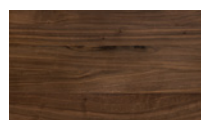

82
Nussbaum, geölt
Noyer, huilé
Walnut, oiled

Kissen zu Kopfteilen | Coussins pour têtes de lit | Cushions for headboards

Arona + Duetto



Lumo + Duetto



Ravo + Varus



Suny + Varus



Varo + Varus



Befestigung mit 2 Bändern (Klettverschluss)

Fixation avec 2 bandes (Velcro®)

Fixation with 2 ribbons (Velcro® fastener)

Stoffauswahl/Farben für Kissen siehe Gesamtkatalog

Register 1, Seiten 1.6–1.7 | Choix de tissus/couleurs pour coussins voir catalogue général registre 1, pages 1.6–1.7 | Choice of tissues/colours for cushions see general catalogue index 1, pages 1.6–1.7

Alle Kissen in Echtleder haben Zier- sowie Teilungsnähte. Ausnahmen: Suny und Varo, diese Kissen haben lediglich Ziernähte.

Tous les coussins en cuir véritable ont des coutures décoratives et des coutures de séparation. A l'exception des coussins : Suny et Varo, ces coussins ont uniquement des coutures décoratives.

All cushions in genuine leather have decorative and dividing seams. Exceptions: Suny and Varo, these cushions only have decorative seams.

Kissen | Coussins | Cushions

	Effektive Masse cm Dimension effective cm Effective dimension cm
Arona	86, 116, 136, 156, 176×3,5×25
Lumo	86, 116, 136, 156, 176×6×25
Ravo	80, 110, 130, 150, 170, 190×3,5×35
Suny 2er Set set de 2 set of 2	55×6×40
Varo 2er Set set de 2 set of 2	55×10×35

zu Kopfteilen

pour têtes de lit
for headboards

	Duetto	Varus
	●	
	●	
	●	●
	●	●
	●	●

Breitenmasse cm

Dimensions de largeur cm
Widths dimensions cm

90/100, 120, 140, 160, 180/200
90/100, 120, 140, 160, 180/200
90/100, 120, 140, 160, 180, 200



selezione

01

MODELLAUSWAHL

Sélection du modèle | Model selection

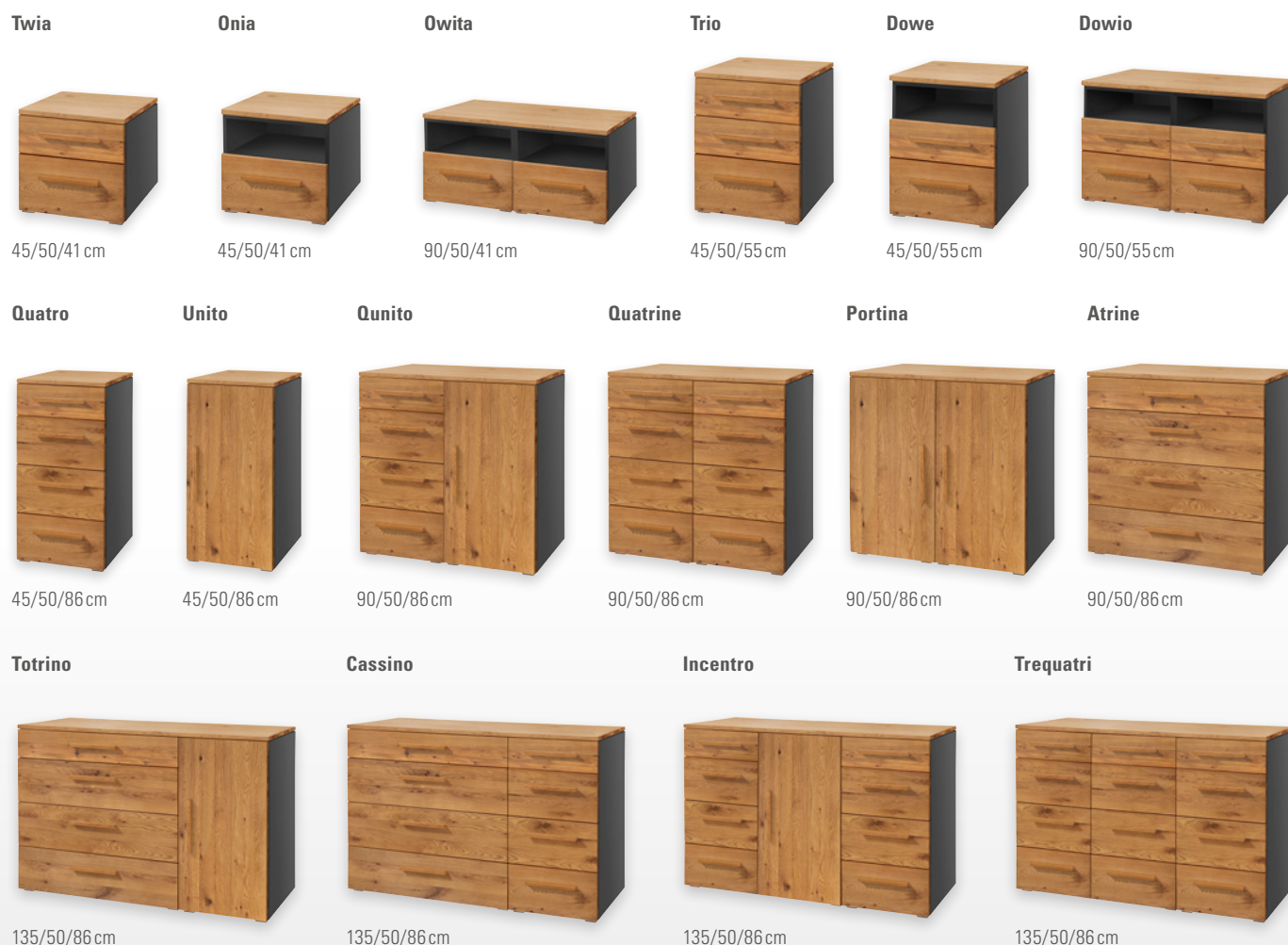
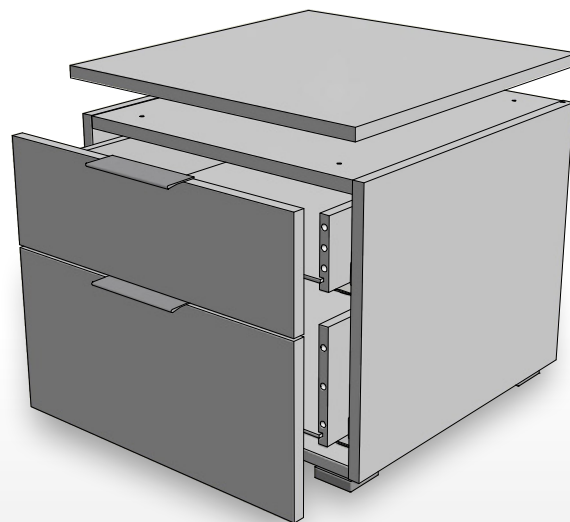

Stellen Sie sich Ihr Wunsch-Beimöbel nach Ihrem Geschmack zusammen: Der Korpus (Abb. 02), in zwei verschiedenen Farbvarianten, lässt sich zu den Front- und Top-Covern (Abb. 03) in acht Holz- und Farbausführungen kombinieren. Die Beimöbel können zerlegt oder teilmontiert bestellt werden. Bei zusammengesetzten Möbeln (z. B. Qunito, Incentro, ...) muss der Deckel noch montiert werden. Bei Kommoden mit Türen ist jeweils ein Einlegeboden vorhanden, Türöffnung nach links oder rechts möglich. Zusätzliche Böden sind erhältlich.

Composez le meuble d'appoint de vos rêves selon vos goûts : Le caisson (ill. 02), disponible en 2 variantes de couleurs, peut être combiné avec les façades et couvercles supérieurs (ill. 03) en 8 finitions de bois et de coloris. Les meubles d'appoint peuvent être commandés en kits ou assemblés. Pour les meubles assemblés (p. ex. Qunito, Incentro, ...) le couvercle doit encore être fixé. Les commodes avec portes sont équipées d'une étagère, ouverture de la porte possible à gauche ou à droite. Si besoin, des étagères supplémentaires sont disponibles.

Put together the side furniture you want according to your own taste: The body (fig. 02), in two different colour versions, can be combined with the front and top covers (fig. 03) in eight wood and colour versions. The furniture can be ordered disassembled or assembled. For assembled furniture (e.g. Qunito, Incentro, ...) the top cover must still be fitted. Chests of drawers with doors have one shelf, door opening possible to the left or right. Additional shelves are available.



Kombinationsbeispiele und techn. Informationen
Exemples et informations
Examples and informations

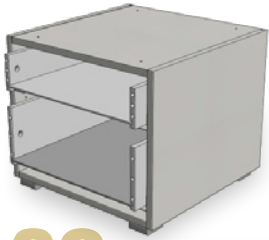

02

KORPUS

Caisson | Body



03

TOP/FRONT

Farben | Couleurs | Colours

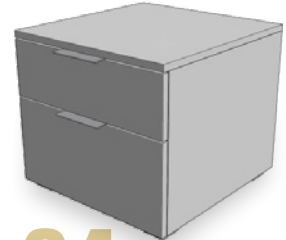

04

GRIFFE

Poignées | Handles



10 Weiss | Blanc | White



16 Anthracit | Anthracite



FÜSSE

Pieds | Feet

STANDARD



OPTION

Leg 8 cm

Jone 10 cm

Cila 10 cm



alu



anthracit
used



anthracit



10 Weiss | Blanc | White



16 Anthracit | Anthracite

STANDARD



Alu

Griff zu Folienfronten

Poignée pour façades en mélaminé
Handle for foil fronts

STANDARD



Holzgriff zu Holzfronten

Poignée en bois pour façades en bois
Wooden handle for wooden fronts

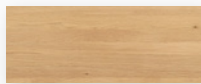

74 Eiche bright, geölt
Chêne bright, huilé
Oak bright, oiled

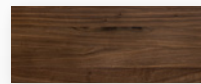

82 Nussbaum, geölt
Noyer, huilé
Walnut, oiled

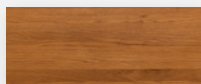

76 Eiche brandy, geölt
Chêne brandy, huilé
Oak brandy, oiled



87 Wildbuche natur, geölt
Hêtre nouveau naturel, huilé
Wildbeech natural, oiled



80 Kernbuche natur, geölt
Hêtre coeur rouge
naturel, huilé
Heart beech natural, oiled

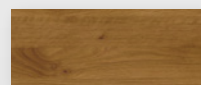

99 Wildeiche natur, geölt
Chêne nouveau naturel, huilé
Wildoak natural, oiled

OPTION

Rivo



Used



Anthracit

Metalgriff zu Holzfronten

Poignée en métal pour façades en bois
Metal handle for wooden fronts



The mark of
responsible forestry
FSC® C123546

Look for FSC® certified products



				Dimension cm
Sola	Bank	Banquette	Bench	140/37/38
Topia	Kissen, Capo linen 763	Coussin, Capo linen 763	Cushion, Capo linen 763	140/37/10
Trigo	Nachtisch	Table de nuit	Bedside table	48/43/55

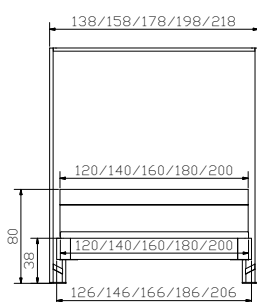
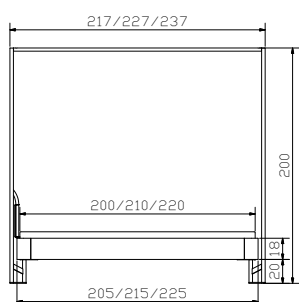



				Dimension cm
Syma 18	Rahmen Breiten Längen	Cadre Largeurs Longueurs	Frame Widths Lengths	120, 140, 160, 180, 200 200, 210, 220
Cielo-Ron anthracit	Baldachin Breiten Längen Höhe	Baldaqin Largeurs Longueurs Hauteur	Canopy Widths Lengths Height	120, 140, 160, 180, 200 200, 210, 220 20
Vela	Baldachin-Tuch, Baumwolle weiss Breiten Länge	Tissu de baldaqin, coton blanc Largeurs Longueur	Canopy cloth, cotton white Widths Length	120, 140, 160, 180, 200 200
Vola	Kopfteil	Tête de lit	Headboard	120, 140, 160, 180, 200

Alle Holzteile in Nussbaum, geölt | Toutes les parties en bois en noyer, huilé | All wooden parts in walnut, oiled

Weitere Beimöbel siehe Gesamtkatalog Register 2 | Autres accessoires voir catalogue général registre 2 | Further accessories see general catalogue index 2



				Dimension cm
Sola	Bank	Banquette	Bench	140/37/38
Vano	Kissen, Kitana beige 600	Coussin, Kitana beige 600	Cushion, Kitana beige 600	136/34/4
Claudio alu	Herrendiener	Valet	Dressboy	45/28/107
Noma	Nachtisch	Table de nuit	Bedside table	48/43/39



Details siehe Seite Gesamtkatalog 8.7

Détails voir catalogue général page 8.7

Details see general catalogue page 8.7



				Dimension cm
Syma 18	Rahmen Breiten Längen	Cadre Largeurs Longueurs	Frame Widths Lengths	90, 100, 120, 140, 160, 180, 200 200, 210, 220
Practico-Ron Box	Breiten Längen Höhe	Largeurs Longueurs Hauteur	Widths Lengths Height	90, 100, 120, 140, 160, 180, 200 200, 210, 220 25
Ripo	Kopfteil, Kitana beige 600 siehe Gesamtkatalog Register 1	Tête de lit, Kitana beige 600 voir catalogue général registre 1	Headboard, Kitana beige 600 see general catalogue index 1	90, 100, 120, 140, 160, 180, 200

Alle Holzteile in Kernbuche natur, geölt | Toutes les parties en bois en hêtre cœur rouge naturel huilé | All wooden parts in heart beech natural, oiled

Weitere Beimöbel siehe Gesamtkatalog Register 2 | Autres accessoires voir catalogue général registre 2 | Further accessories see general catalogue index 2

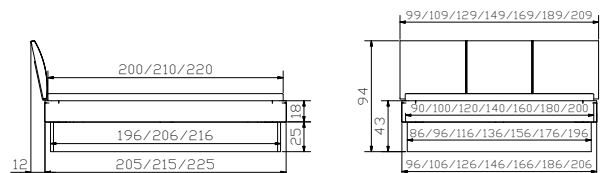



				Dimension cm
Sigma	Kommode	Commode	Chest of drawers	120/49/76
Cila 10 anthracit	Füsse	Pieds	Feet	
Noma	Nachttisch	Table de nuit	Bedside table	48/43/39
Cila 10 anthracit	Füsse	Pieds	Feet	

Alle Holzteile in Nussbaum, geölt | Toutes les parties en bois en noyer, huilé | All wooden parts in walnut, oiled

Leselampen und weitere Beimöbel siehe Gesamtkatalog Register 2 | Lampes de lecture et autres accessoires voir catalogue général registre 2 | Reading lamps and further accessories see general catalogue index 2



				Dimension cm
Syma 18	Rahmen Breiten Längen	Cadre Largeurs Longueurs	Frame Widths Lengths	90, 100, 120, 140, 160, 180, 200 190, 200, 210, 220
Facito anthracit	Eckfüsse Höhe	Pieds d'angles Hauteur	Corner feet Height	20
Vola	Kopfteil	Tête de lit	Headboard	90/100, 120, 140, 160, 180, 200

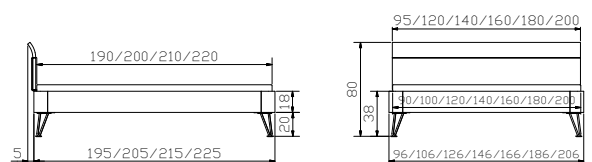



				Dimension cm
Sola	Bank	Banquette	Bench	140/37/38
Vano	Kissen, Boucle fresco 772	Coussin, Boucle fresco 772	Cushion, Boucle fresco 772	136/34/4
Aska	Sekretär	Secrétaire	Bureau	120/60/85
Caja	Nachttisch	Table de nuit	Bedside table	48/41/16
Smart white	Leselampe (2er Set) 12V DC, 30 LED warm	Lampe de lecture (set de 2) 12V DC, 30 LED warm	Reading lamp (set of 2) 12V DC, 30 LED warm	

Alle Holzteile in Buche weiss deckend, lackiert | Toutes les parties en bois en hêtre blanc couvrant, laqué | All wooden parts in beech white covered, lacquered
Leselampen und weitere Beimöbel siehe Gesamtkatalog Register 2 | Lampes de lecture et autres accessoires voir catalogue général registre 2 | Reading lamps and further accessories see general catalogue index 2



				Dimension cm
Syma 18	Rahmen Breiten Längen	Cadre Largeurs Longueurs	Frame Widths Lengths	90, 100, 120, 140, 160, 180, 200 190, 200, 210, 220
Xylo	Eckfüsse Höhen	Pieds d'angles Hauteurs	Corner feet Heights	20(38), 25(43), 30(48)
Vola	Kopfteil	Tête de lit	Headboard	90/100, 120, 140, 160, 180, 200

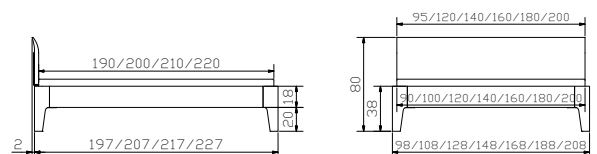



				Dimension cm
Lovie-Ron Box	1 Bettkasten	1 Tiroir de lit	1 Bed drawer	90, 100, 120, 140
	Breiten	Largeurs	Widths	
	2 Bettkästen	2 Tiroirs de lit	2 Bed drawers	140, 160, 180, 200
	Breiten	Largeurs	Widths	
	Höhe	Hauteur	Height	25

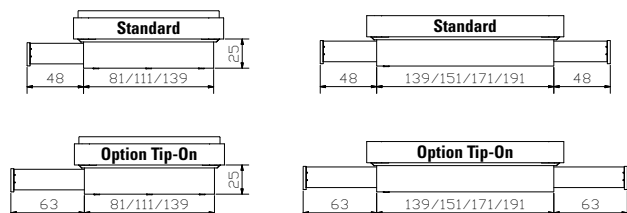



				Dimension cm
Syma 18	Rahmen Breiten Längen	Cadre Largeurs Longueurs	Frame Widths Lengths	90, 100, 120, 140, 160, 180, 200 190, 200, 210, 220
Boga	Kopfteil, Fusio shell 750 siehe Gesamtkatalog Register 1	Tête de lit, Fusio shell 750 voir catalogue général registre 1	Headboard, Fusio shell 750 see general catalogue index 1	90, 100, 120, 140, 160, 180, 200
Sigma Sima 20	Kommode Füsse	Commode Pieds	Chest of drawers Feet	120/49/86
Noma Sima 10	Nachttisch Füsse	Table de nuit Pieds	Bedside table Feet	48/43/47

Alle Holzteile in Buche weiss deckend, lackiert

Toutes les parties en bois en hêtre blanc couvrant, laqué
All wooden parts in beech white covered, lacquered

Weitere Beimöbel siehe Gesamtkatalog Register 2 | Autres accessoires voir catalogue général registre 2 | Further accessories see general catalogue index 2

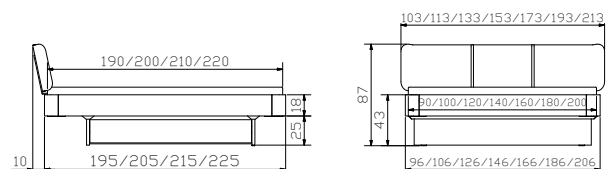



				Dimension cm
Quatro	Kommode	Commode	Chest of drawers	45/49/85
Twia	Nachttisch	Table de nuit	Bedside table	45/49/40

Alle Holzteile in Buche weiss deckend, lackiert oder weiss | Toutes les parties en bois en hêtre blanc couvrant, laqué ou blanc | All wooden parts in beech white covered, lacquered or white

Weitere Beimöbel siehe Gesamtkatalog Register 2 | Autres accessoires voir catalogue général registre 2 | Further accessories see general catalogue index 2



				Dimension cm
Syma 18	Rahmen Breiten Längen	Cadre Largeurs Longueurs	Frame Widths Lengths	140, 160, 180, 200 190, 200, 210, 220
Slitto white	Kufen Breiten Höhen	Patins Largeurs Hauteurs	Vats Widths Heights	140, 160, 180, 200 20, 25
Cussina	Kopfteil, Boston clay 650 siehe Gesamtkatalog Register 1	Tête de lit, Boston clay 650 voir catalogue général registre 1	Headboard, Boston clay 650 see general catalogue index 1	140, 160, 180, 200

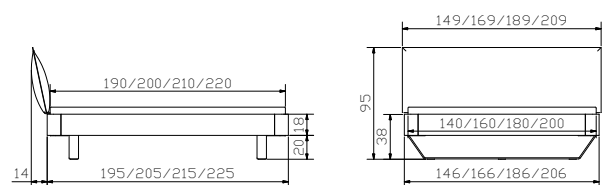



Circo 44

Nachttisch

Table de nuit

Bedside table

Dimension cm

Ø 45/44

Alle Holzteile in Nussbaum, geölt | Toutes les parties en bois en noyer, huilé | All wooden parts in walnut, oiled

Weitere Beimöbel siehe Gesamtkatalog Register 2 | Autres accessoires voir catalogue général registre 2 | Further accessories see general catalogue index 2



				Dimension cm
Syma 18	Rahmen Breiten Längen	Cadre Largeurs Longueurs	Frame Widths Lengths	90, 100, 120, 140, 160, 180, 200 190, 200, 210, 220
Xylo	Eckfüsse Höhen	Pieds d'angles Hauteurs	Corner feet Heights	20(38), 25(43), 30(48)
Vola	Kopfteil	Tête de lit	Headboard	90/100, 120, 140, 160, 180, 200

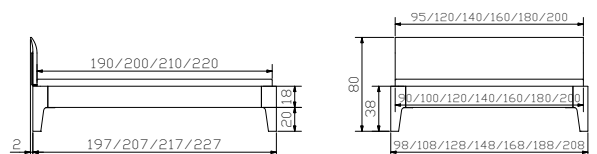



				Dimension cm
Topa anthracit	Bank, inkl. Kissen Fusio shell 750	Banquette, coussin incl. Fusio shell 750	Bench, cushion incl. Fusio shell 750	144/44/38
Quatro	Kommode	Commode	Chest of drawers	45/50/86
Nali anthracit	Nachttisch	Table de nuit	Bedside table	Ø 48//52
Smart black	Leselampe (2er Set) schwarz 12V DC, 30 LED warm Dreistufenschaltung	Lampe de lecture (set de 2) noir 12V DC, 30 LED warm Interrupteur à 3 crans	Reading lamp (set of 2) nero 12V DC, 30 LED warm Three step circuit	

Alle Holzteile in Nussbaum, geölt | Toutes les parties en bois en noyer, huilé | All wooden parts in walnut, oiled

Quatro: Korpus anthracit | Caisson anthracite | Body anthracite

Leselampen und weitere Beimöbel siehe Gesamtkatalog Register 2 | Lampes de lecture et autres accessoires voir catalogue général registre 2 | Reading lamps and further accessories see general catalogue index 2



				Dimension cm
Syma 18	Rahmen Breiten Längen	Cadre Largeurs Longueurs	Frame Widths Lengths	140, 160, 180, 200 190, 200, 210, 220
Tondito anthracit	Eckteile + Füße Höhe	Pièces d'angles + pieds Hauteur	Corner pieces + feet Height	20
Sogno L	Wandpaneele Fusio shell 750 siehe Gesamtkatalog Register 1	Panneaux muraux Fusio shell 750 voir catalogue général registre 1	Wallpanel Fusio shell 750 see general catalogue index 1	161, 181, 201, 221

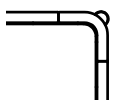

Der Fuss Tondito ragt 17 mm über das Eckteil.
Le pied Tondito dépasse de 17 mm de la pièce d'angle.
The Tondito feet protrudes 17 mm over the corner piece.

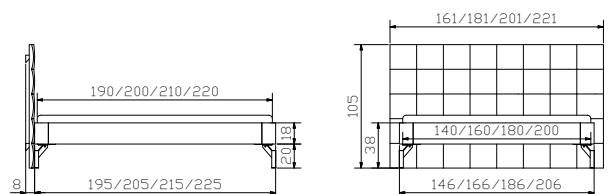



				Dimension cm
Sola	Bank	Banquette	Bench	140/37/38
Vano	Kissen, Boucle mouse 773	Coussin, Boucle mouse 773	Cushion, Boucle mouse 773	136/34/4
Circo 44	Nachttisch	Table de nuit	Bedside table	Ø 45/44

Alle Holzteile in Nussbaum, geölt | Toutes les parties en bois en noyer, huilé | All wooden parts in walnut, oiled

Weitere Beimöbel siehe Gesamtkatalog Register 2 | Autres accessoires voir catalogue général registre 2 | Further accessories see general catalogue index 2



				Dimension cm
Syma 18	Rahmen Breiten Längen	Cadre Largeurs Longueurs	Frame Widths Lengths	90, 100, 120, 140, 160, 180, 200 190(200), 200(210), 210(220)
Xylo	Eckfüsse Höhen	Pieds d'angles Hauteurs	Corner feet Heights	20(38), 25(43), 30(48)
Cemoa	Kopfteil, Boucle mouse 773 hat Einfluss auf Bettlänge siehe Seite 6	Tête de lit, Boucle mouse 773 a un impact sur la longueur du lit voir page 6	Headboard, Boucle mouse 773 affects the length of bed see page 6	90, 100, 120, 140, 160, 180, 200 90 – 120 = 1 Kissen/Coussin/ Cushion

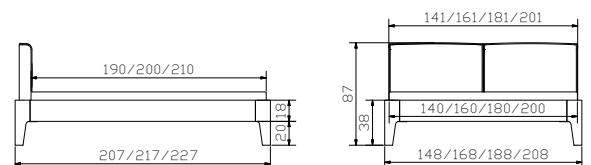



				Dimension cm
Aska	Sekretär	Secrétaire	bureau	120/60/85
Sola	Bank	Banquette	bench	140/37/38
Topia	Kissen, Capo taupe 765	Coussin, Capo taupe 765	cushion, Capo taupe 765	140/37/10
Trigo	Nachttisch	Table de nuit	bedside table	48/43/55

Alle Holzteile in Kernbuche natur, geölt | Toutes les parties en bois en hêtre cœur rouge naturel, huilé | All wooden parts in heart beech natural, oiled
Weitere Beimöbel siehe Gesamtkatalog Register 2 | Autres accessoires voir catalogue général registre 2 | Further accessories see general catalogue index 2



				Dimension cm
Syma 18	Rahmen Breiten Längen	Cadre Largeurs Longueurs	Frame Widths Lengths	140, 160, 180, 200 190, 200, 210, 220
Ronda	Eckfüsse Höhen	Pieds d'angles Hauteurs	Corner feet Heights	20(38), 25(43), 30(48)
Umbia L	Wandpaneel Capo taupe 765 nur für Wandmontage siehe Gesamtkatalog Register 1	Panneau mural Capo taupe 765 uniquement pour montage mural voir catalogue général registre 1	Wall panel Capo taupe 765 wall assembly only see general catalogue index 1	153, 173, 193, 213

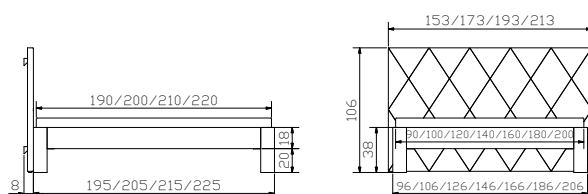



				Dimension cm
Aska	Sekretär	Secrétaire	Bureau	120/60/85
Noma	Nachttisch	Table de nuit	Bedside table	48/43/39
Sima 10	Füsse	Pieds	Feet	

Alle Holzteile in Nussbaum, geölt | Toutes les parties en bois en noyer, huilé | All wooden parts in walnut, oiled

Weitere Beimöbel siehe Gesamtkatalog Register 2 | Autres accessoires voir catalogue général registre 2 | Further accessories see general catalogue index 2



				Dimension cm
Syma 18	Rahmen Breiten Längen	Cadre Largeurs Longueurs	Frame Widths Lengths	90, 100, 120, 140, 160, 180, 200 190, 200, 210, 220
Masito	Eckteile + Füße Höhen	Pièces d'angles + pieds Hauteurs	Corner pieces + feet Heights	20, 25
Vola	Kopfteil	Tête de lit	Headboard	90/100, 120, 140, 160, 180, 200

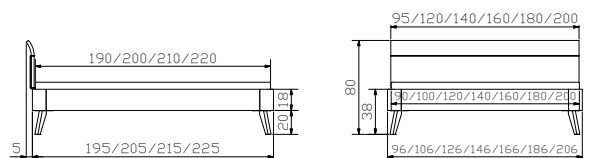



MOVIE-/TOP LINE



FACTORY LINE



WOOD LINE



LOUNGE



FINE LINE



NATURO LINE



OAK LINE



OAK WILD



DREAM LINE



**EDITION
BOXSPRING**



**FUNCTION/COMFORT
KIDS & GUESTS**



**LATTENROSTE &
MATRATZEN**



Gesamtkatalog
Catalogue général
General catalogue

Schlafwohl
Markenmatratzen & Bettsysteme